

This Conference Paper is archived in Dspace@nitr



<http://dspace.nitrkl.ac.in/dspace>

A Rapid Screening Tool to Predict Optimal Feed Flow Sequence of A Multiple Effect Evaporator System Using Process Integration

19th National & 8th ISHMT-ASME
Heat and Mass Transfer Conference
January 3 - 5, 2008
JNTU Hyderabad, India

A Rapid Screening Tool to Predict Optimal Feed Flow Sequence of A Multiple Effect Evaporator System Using Process Integration

S. Khanam

Department of Chemical Engineering
National Institute of Technology Rourkela
Rourkela – 769 008
shabinahai@gmail.com, skhanam@nitrrkl.ac.in

B. Mohanty

Department of Chemical Engineering
Indian Institute of Technology Roorkee
Roorkee – 247 667
bmohanty@iitr.ernet.in

Abstract

A simple mathematical model based on principles of Process Integration (PI) has been developed to screen the optimal feed flow sequence (OFFS) of a multiple effect evaporators (MEE) system which will offer best steam economy.

The model assumes fresh feed to be composed of streams of product and different condensate streams. It also takes in to account *temperature paths* followed by each stream and internal heat exchange between hot and cold parts of a stream along with variable physical properties of steam/vapor and condensates. A septuple effect flat falling film evaporator (SEFFFE) system with steam splitting and feed, product and condensate flashing, used to concentrate weak black liquor, is considered for simulation. The set of linear algebraic equations of the model is solved simultaneously using Gaussian elimination method with partial pivoting. Backward feed flow sequence is found to be the optimum for the system. The results of the present model are also compared with other models and found to agree well as far as selection of OFFS is concerned.

Key words: Multiple effect evaporator, Rapid screening tool, Optimal feed flow sequence, Linear model.

Nomenclature

C_{PP}	Specific heat capacity of product, kJ/kg/K
C_{PW}	Specific heat capacity of condensate, kJ/kg/°C
F	Feed flow rate, kg/h
h	Enthalpy of condensate, kJ/kg
H	Enthalpy of vapor, kJ/kg
n	Number of effects
P	Flow rate of product stream, kg/h

T	Vapor body temperature, °C
V	Vapor flow rate, kg/h
x	Mass fraction
Greek letters	
Δ	Difference in values of a parameter at two points
λ	Heat of vaporization, kJ/kg
Subscripts	
1,2,3,4,5,6,7,k	Seven effects
F	Feed
0	Live steam entering into first effect
L	Liquor
P	Product
r	Reference
V	Vapor

1. Introduction

An energy audit shows that Multiple Effect Evaporator (MEE) House of a Pulp and Paper industry consumes about 24-30% of its total energy and thus has been a topic of investigation for last many decades [1]. The main efforts are towards the development of operating strategies which should consume minimum live steam and thus provide maximum steam economy. The operating strategies include selection of best flow sequences of liquor and feed-, product- & condensate-flashing though it makes the system complex. However, screening of the best strategy, out of the feasible ones, is time and resource consuming and if done experimentally becomes an arduous task. One of the reasonable way of doing it is through simulation.

Harpor and Tsao [2] developed a model for the optimization of evaporation process for a few feed flow sequence (FFS) such as forward and backward FFS. Nishitani and Kunugita [3] extended the work of Harpor and Tsao [2] to propose an algorithm for generating non-

inferior FFS amongst all possible FFSs of a MEE system. The non-inferior FFSs were based on the constraints of viscosity of liquid and the formation of scale or foam.

The above discussed models are generally based on set of non-linear equations and accommodate varying physical properties for vapor/steam and liquor. It either uses fixed overall heat transfer coefficient (OHTC) or variable OHTC based on empirical equations or mathematical models. Further, it has also been observed that to address different flow sequences the complete set of equations need to be changed and thus offers difficulty in handling.

To address this problem cascade algorithm has been developed in which the model of an evaporator body is solved repeatedly [4] & [5]. With the change in flow sequence the sequence of the solution of the model and also the input data to this model changes. Though this model removed the above said weaknesses of the general simulation models it exhibits convergence and stability problem during solution [6].

Under the above backdrop the present investigation has been planned to develop a simplified mathematical model based on principles of Process Integration, stream analysis, temperature path and internal heat exchange

conceptualized by Westerberg and Hillenbrand [7]. The present model has been improved to address all operating configurations like steam splitting, feed-, product- and condensate- flash.

2. Problem Statement

The MEE system shown in Fig.1 - a Septuple Effect Flat Falling Film Evaporator (SEFFFE) system operating in a nearby paper mill with backward FFS is used for concentrating weak black liquor. The first two effects of it are finishing evaporators and use direct live steam. This system employs feed and product flashing along with primary and secondary condensate flashing to generate vapor, which are used in vapor bodies to improve overall steam economy of the system. The seventh effect is attached to a vacuum unit. The operating parameters for this system are given in Table 1 and feasible FFS are shown in Table 2 which are studied in order to obtain the OFFS that yields highest possible steam economy.

Table 1 Operating parameters for the SEFFFE system

Parameter(s)	Value	Parameter(s)	Value	
Total number of effects	7	Black liquor feed flow rate	56200 kg/h	
Number of effects being supplied live steam	2	Last effect vapor temperature	52 °C	
Live steam temperature	Effect 1	140 °C	Feed flow sequence	Backward
	Effect 2	147 °C		
Black liquor inlet concentration	0.118	Feed flash tank position	As indicated in the Fig. 1	
Black liquor outlet concentration	0.54	Product flash tank position		
Liquor inlet temperature	64.7°C	Primary and secondary condensate flash tank position		

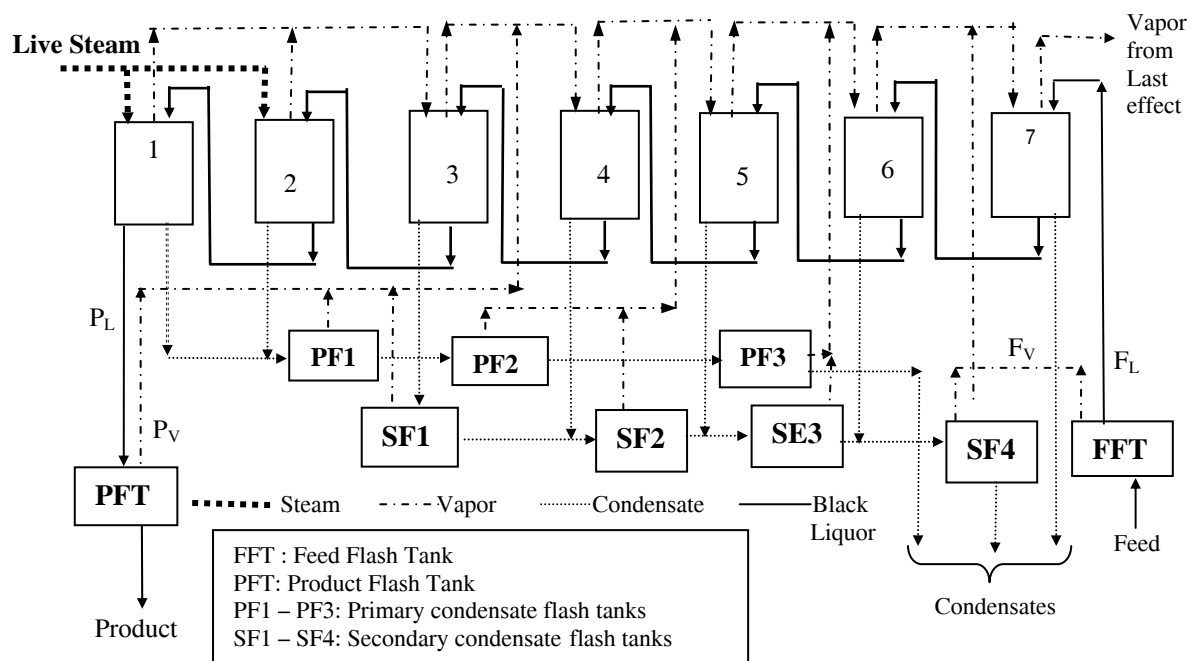

Fig. 1 Schematic diagram of a SEFFFE system with backward feed flow sequence

Table 2 Feasible liquor flow sequences in a SEFFFE system

FFS	Liquid Flow Sequence	FFS	Liquid Flow Sequence
S1	7→6→5→4→3→2→1	S4	4→5→6→7→3→2→1
S2	6→7→5→4→3→2→1	S5	3→4→5→6→7→2→1
S3	5→6→7→4→3→2→1	S6	4→5→6→7→1→2→3

3. Model Development

A simplified model, based on the principles of PI and based on the concepts of Westerberg and Hillenbrand [7], is developed for a SEFFFE system with backward FFS. The model uses some assumptions to cut down the complexity. These are: driving force for the transfer of heat from steam/vapor to boiling liquor is constant for each effect, vapor body temperatures of effects are fixed for all FFS, boiling point rise, heat losses from all effects and heat of mixing between different streams of feed are also negligible.

3.1. Description of the System

A simple system based on Fig. 1 is considered for the development of the model. In this system live steam of amount, W_s , enters into the steam chest of the first effect at temperature T_0 and exits it as a condensate stream C_s (where, $W_s = C_s$) after supplying latent heat for vaporization to the first effect. The vapor generated in the first effect, as a result of evaporation of liquor, is moved to the vapor chest of the second effect and affects evaporation in this effect. This sequence is repeated up to last effect. Feed first enters into effect 7 and then follows the backward sequence.

For this model the feed is hypothetically considered to be composed of eight different streams, which for the purpose of computation move separately through the system without any interference from other streams. The details of above said eight streams are as follows: one product stream, P , and seven condensate streams designated as, $C_1, C_2, C_3, C_4, C_5, C_6$ and C_7 , shown in Fig. 2.

Movements of these streams is detailed below: Initially the feed which is the combination of product, P , and seven condensate streams, C_1 to C_7 , are at feed temperature, T_F , and enter to the seventh effect. From this effect condensate stream " C_7 " which is the condensate stream derived from vapor stream " V_7 " comes out. Thus, the remaining streams of liquor are P and C_1 to C_6 . These streams exit seventh effect at a temperature T_7 and enter effect No. 6. The liquor is evaporated in it and in turn vapor stream " V_6 " is produced which is sent to effect No.7 as heating media.

After giving its heat to effect No.7 this stream converts it self in to condensate stream " C_6 " and exits from the vapor chest of effect No.7. In fact, in this effect two condensate streams " C_7 " & " C_6 " are separated which is uncommon in other effects. Exit liquor from sixth effect at temperature T_6 , which is the combination of product stream P and condensate streams C_5 to C_1 , enters the effect No.5. In the similar manner, condensate streams " C_5 " to " C_1 " get separated one by one from the vapor chests of effects No. 6 to 2, respectively. Finally, the product stream " P " comes out from effect No.1. The above fact is schematically presented in Fig.2.

To trace the level of temperatures a particular stream acquires while it traverses from entry effect to exit effect (sequence of entry and exit depends on flow sequence) the concept of "*temperature path*" is used. It is defined as a "Path followed by the temperatures of a stream when it passes through an effect or a network of it". It should be noted that concept of temperature path is only valid for streams having sensible heat. It plays a vital role in the development of model equations. For present case, the temperature paths of all eight constituent streams of feed are shown in Fig. 3 in which $T_1, T_2, T_3, T_4, T_5, T_6$ and T_7 are vapor body temperatures of 1st, 2nd, 3rd, 4th, 5th, 6th and 7th effects, respectively. The temperature paths are plotted to demonstrate another important concept called "*internal heat exchange*". This concept works on one of the basic principles of PI, called "maximum energy recovery". It allows different streams or their part to exchange heat with each other in order to know the maximum amount of heat that can be recovered through internal exchange and thus provides a mean to reduce the amount of live steam required by the system.

To demonstrate the concept of "*internal heat exchange*" let us consider the temperature path of P , shown in Fig. 3, which first moves downward in temperature from point "a" to "c" through point "b" and hence behaves as a hot stream. However, the same stream from point "d" to "f" through "e" works as a cold stream as its temperature rises in this temperature path. When the product stream is working as a hot stream it can provide heat to a compatible cold stream. In the same manner when it is working as a cold stream it can take heat from a compatible hot stream.

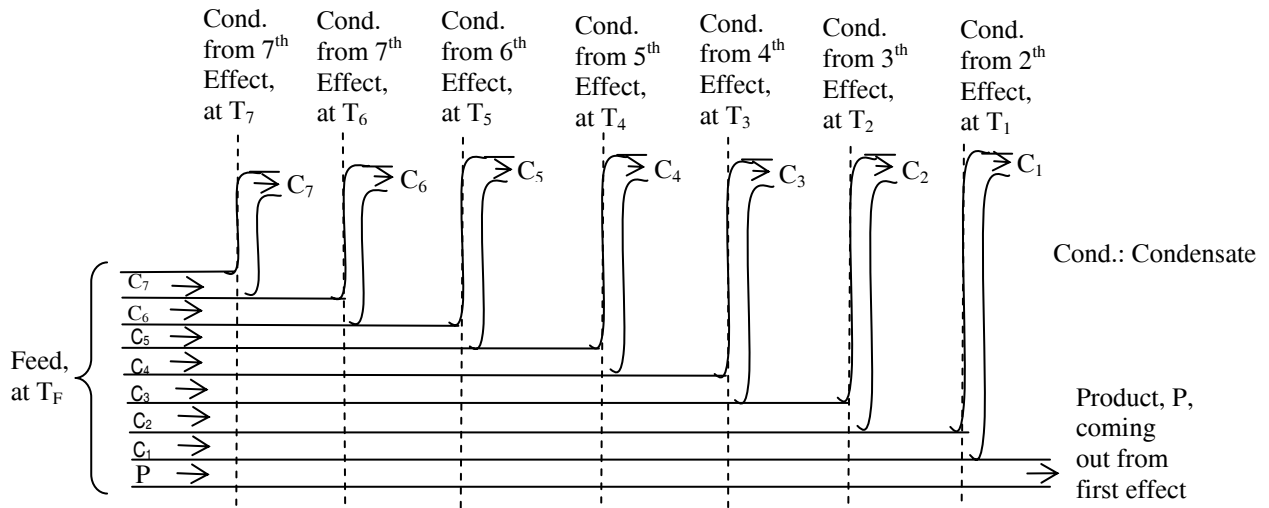

Fig. 2 Movement of product, P, and seven condensate streams, C_1 to C_7 , through the SEFFFE system

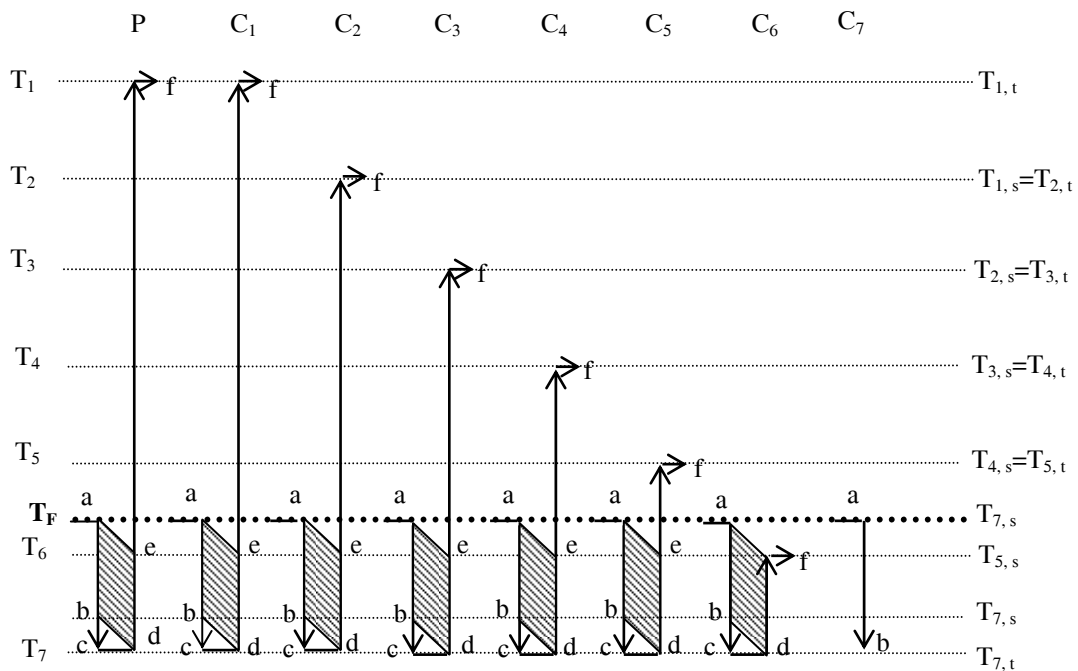

Fig. 3 Temperature paths of different streams of feed for a SEFFFE system for backward FFS

In fact, when two streams exchange heat there exist a minimum temperature difference, ΔT . As a first guess it can be taken as 10°C . As the product stream “P” behaves as hot stream in some part of the temperature path and as cold stream in remaining path while traversing the complete *temperature path* its hot stream part can exchange heat with its cold stream part subjected to the ΔT_{\min} constraint. The hot stream part of “P”, denoted by “a” to “c” through “b”, first cools down from point “a” to “b” by exchanging its heat with cold stream part of it. In

turn the temperature of cold stream rises from point “d” to “e”. In fact the above referred hot stream temperature can not drop below point “b” which is equal to $T_7 + \Delta T_{\min}$, while exchanging heat with the corresponding cold stream as it will violate ΔT_{\min} criterion. In this case, the product stream P enters into the seventh effect at point “b” where it is cooled down and reach at point “c” before gets evaporated. Therefore, in this case, for stream, P, maximum possible internal heat exchange is equal to $[P \cdot C_{pp} \cdot (T_F - T_7 - \Delta T_{\min})]$ kW.

The Model-M1, for the simple SEFFFE system has been developed with the help of *Temperature Paths*, shown in Fig. 3. To develop equation for an effect the temperatures at which liquor enters (supply temperature, T_s) and exits (target temperature, T_t) from the effect should be known. These temperatures can be obtained from the Fig. 3. For example, to develop equation for the first effect supply and target temperatures are taken as T_2 and T_1 , respectively. Further, it can be seen from Fig. 3 that only streams, P and C_1 , enter into first effect. Due to evaporation, C_1 amount of vapor is produced in this effect at T_1 . Thus, energy balance around first effect at steady state provides following equations:

$$\begin{aligned} &\text{Latent heat supplied by live steam at } T_0 \\ &+ \text{Sensible heat of entering streams, P \& C}_1 \text{ at } T_{1,s} \\ &+ \text{Sensible heat of exiting streams, P \& C}_1 \text{ at } T_{1,t} \end{aligned} = \begin{aligned} &\text{Latent heat available with the stream, } C_1 \text{ at } T_{1,t} \end{aligned} \quad (1)$$

Latent heat supplied by live steam at $T_0 = W_s * \lambda_s$ (2)
Sensible heat of streams, P and C_1 , which enters the first effect at $T_{1,s}$ is:

$$P * C_{PP} * (T_{1,s} - T_r) + C_1 * [T_{1,s} * C_{PW} (T_{1,s}) - T_r * C_{PW} (T_r)] \quad (3)$$

where, $C_{PP} = 4.187 * (1 - 0.0054 * x_p)$

C_{PW} and T_r are specific heat capacity of condensate and reference temperature, respectively.

Latent heat available with the exit vapor stream of amount C_1 at $T_{1,t} = C_1 * \lambda_1$ (4)

Sensible heat of exiting streams from first effect at $T_{1,t}$ is:

$$P * C_{PP} * (T_{1,t} - T_r) + C_1 * [T_{1,t} * C_{PW} (T_{1,t}) - T_r * C_{PW} (T_r)] \quad (5)$$

When Eqs. 2, 3, 4 and 5 are substituted in Eq. 1 with $T_{1,s}$ & $T_{1,t}$ equal to T_2 & T_1 and rearranging it, one gets following equation for first effect:

$$W_s \left[\frac{\lambda_s}{\lambda_1} \right] + C_1 \left[\frac{b_1}{\lambda_1} - 1 \right] + \frac{PC_{PP}(T_2 - T_1)}{\lambda_1} = 0 \quad (6)$$

Where, $b_1 = [T_2 * C_{PW} (T_2) - T_1 * C_{PW} (T_1)]$

Similarly, equation for six other effects can be developed. Overall mass balance around the SEFFFE system provides:

$$C_1 + C_2 + C_3 + C_4 + C_5 + C_6 + C_7 = F - P \quad (7)$$

3.2. Induction of Condensate Flashing in the Model

Model-M1 is further developed by inducting the provisions of primary and secondary condensate flash as shown in Fig. 1. This model is called Model-M2. The condensate exits from steam/vapor chest of an effect contains sufficient amount of sensible heat which can be

extracted by means of flashing to produce low pressure vapor and can be used as heating medium.

For Model-M2 steam splitting and feed and product flashing are not considered. For this case live steam is used only in first effect and its condensate, CS, exits from first effect and enters into flash tank, PF1. The vapor stream, V_1 , enters into vapor chest of second effect and condensate of it, C_1 , exits this effect and re-enters to flash tank, SF1. Feed directly enters into effect 7 at T_f and product, P, comes out from first effect at T_1 .

For this system, live steam of amount, W_s , enters to the steam chest of first effect at temperature, T_0 and exits it as a condensate, "CS" (where, $W_s = CS$) at the same temperature, T_0 . It should be kept in mind that condensate of live steam is called *primary condensate* whereas; condensate of other vapor stream is referred as *secondary condensate*. In fact when a condensate stream at a high pressure (thus temperature) is flashed (say first flash) at a lower pressure a part of it is vaporized by taking heat from remaining liquid and thus a mixture of low temperature liquid and vapor is produced. Hence, for theoretical interpretation the condensate stream "CS" can be thought of as two streams one liquid and the other vapor stream at one temperature which is lower than the initial temperature of "CS". This process can be repeated with the residual condensate of stream "CS" which is obtained after first flashing. When the above condensate stream is flashed (say second flash) it will also produce two stream one liquid and other vapor at a temperature which will be lower than the initial temperature of residual condensate stream. The vapor stream which was obtained from the first stream will provide heat to an effect and will subsequently convert into a condensate stream. This stream now can also be flashed (say third flash) to get vapor and liquid streams.

After three consecutive flashing the original primary condensate stream "CS" can be assumed to be composed of four streams. Thus, theoretically, a condensate stream can be assumed to be composed of a number of vapor and liquid streams which can be assumed to be physically separated. This concept is used below during the development Model-M2.

The primary condensate stream "CS" enters into flash tank (PF1) and flashed at T_3 to produce vapor stream, CS_v , and liquid stream, CS_L . The stream, CS_v , enters the vapor chest of fourth effect with stream " V_3 ". Both the streams are treated separately to compute their child streams generated out of flashing in different flash units for ease of modeling. In the SEFFFE system *primary condensate* streams are flashed in flash units, PF1 to PF3, and *secondary condensates* are flashed in flash units, SF1 to SF4. The secondary condensate stream, " CS_v " enters the flash unit (SF2) operating at temperature T_4 to generate vapor stream " CS_{vv} " and liquid stream " CS_{vL} ". The vapor stream " CS_{vv} " enters into the vapor chest of fifth effect along with vapor generated in fourth effect, " V_4 ". The liquid stream " CS_{vL} " along with condensate streams " CS_{vv} " enter into flash unit (SF3) operating at temperature T_5 . As a result of it, two vapor streams as

“CS_{VLV}” and “CS_{VVV}” and two liquid streams as “CS_{VLL}” and “CS_{VVL}” are generated here. These streams are considered as separate streams. The same is also true for liquid stream coming out from SF3. Vapor streams “CS_{VLV}” and “CS_{VVV}” along with vapor generated in fifth effect, “V₅”, enter into the vapor chest of sixth effect. Following the same pattern, as shown in Fig. 4, the condensate streams are flashed in flash units SF4 and vapor produced in these units enter in to effect 7. From SF4, the condensate streams, which can not be flashed further, come out at temperature T₆. The complete tree of CS_V which shows the flashing sequences using flash units SF2 to SF4 are shown in Fig. 4. Similarly, the condensate tree of CS_L can be drawn.

The list of different vapor streams generated due to flashing of condensate, CS, and then enter into vapor chests of fourth-, fifth-, sixth- and seventh- effects to work as a heating medium, are provided in Table 3. The expressions required to quantify these streams are developed and shown in Appendix A.

Now the primary condensate stream “CS” can be thought of as a combination of 7 vapor as well as 8 liquid streams. The other flash streams, which are specifically generated from “CS”, and enter into fourth to sixth effect are combination of some of the streams out of the above 15 (7+8) streams. For example the flash vapor stream “CS_{VVV}” which enters into sixth effect is a combination of vapor stream “CS_{VVVV}” and liquid stream “CS_{VVVL}”. It should be noted that the present discussion

relates to only condensate stream, “CS”, and not the streams “C₁” to “C₅”. Based on the logic, discussed above, flashing of *secondary condensate* streams C₁, C₂, C₃, C₄ and C₅ are also treated.

For the present case, feed is assumed to be a composed of eight different streams. The temperature paths of these streams are also shown in Fig. 3. The governing equations for Model-M2 can be derived in the similar manner as of Eq. 6 for Model-M1. The only change required is to include the amount of flash vapor as a heating medium in appropriate effects. Likewise the provisions of feed and product flashing can be incorporated in the SEFFFE system.

3.3. Induction of Live Steam Splitting in the Model

In some of the Pulp and Paper plants, first two effects of a SEFFFE system are used as finishing effects in which live steam is fed. If total steam consumption in first two effects in the system is Ws, then it can be assumed that fraction, fs, of it enters into the first effect at T₀₁ whereas, (1-fs)Ws enters into the second effect at T₀₂. The change in live steam temperatures in first two effects is due to the difference in saturation pressures of the steam chests of these effects.

The condensates of both the streams of live steam are flashed in flash unit PF1 (see Fig. 1) and entered into the steam chest of third effect along with V₁ and V₂.

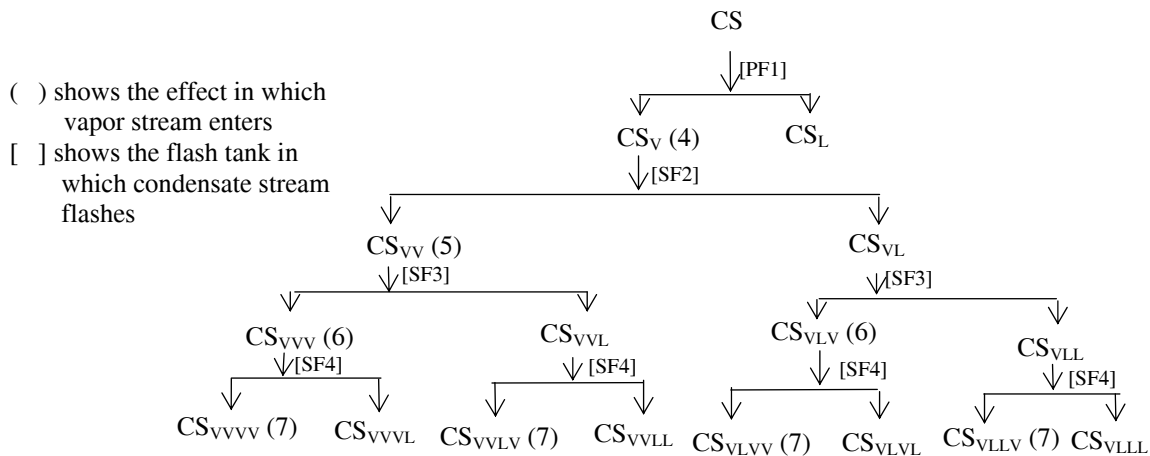

Fig. 4 Condensate tree of stream “CS_V” of primary condensate “CS”

Table 3 Total number of vapor streams entering into effects 2 to 7

Effect	No. of vapor streams	Vapor streams
Fourth	n1=1	CS _V
Fifth	n1=2	CS _{VV} , CS _{LV}
Sixth	n1=4	CS _{VVV} , CS _{VLV} , CS _{LVV} , CS _{LLV}
Seventh	n1=7	CS _{VVVV} , CS _{VVVL} , CS _{VVLV} , CS _{VVLL} , CS _{LVVV} , CS _{LVLV} , CS _{LLVV}

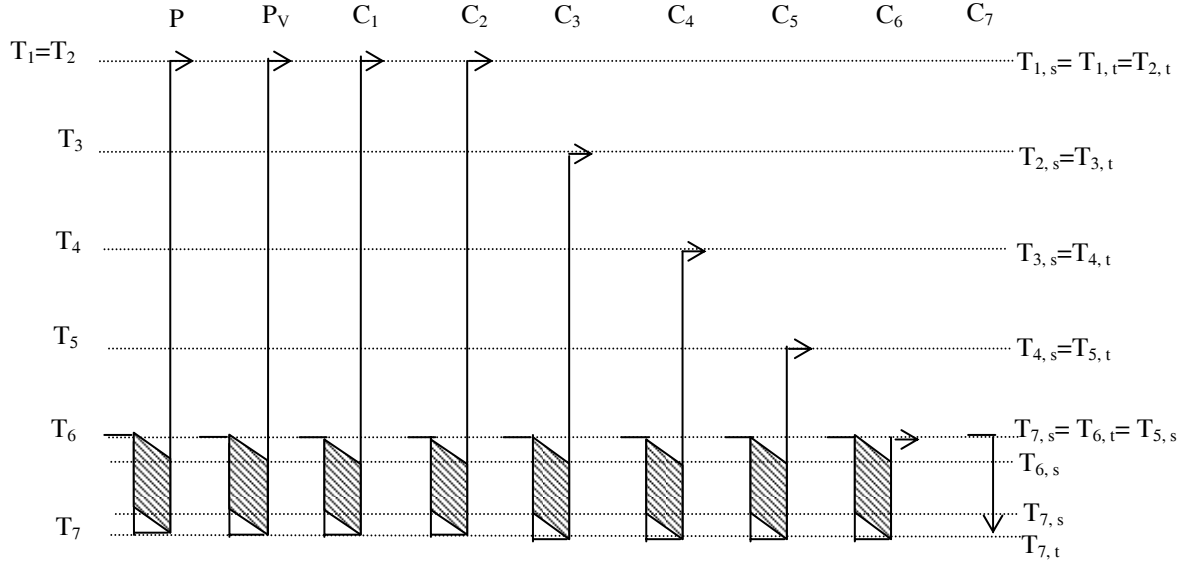

Fig. 5 Temperature paths of different streams of feed for a SEFFFE system, which includes steam splitting

Temperature paths of different streams of feed such as P, P_V, C₁, C₂, C₃, C₄, C₅, C₆ and C₇ are shown in Fig. 5. In this figure condensate streams C₁ and C₂ follow same temperature paths as temperatures of first two effects (from where streams C₁ and C₂ are exiting) are considered to be equal.

The modified model, Model-M3, is developed which contains following equations for effects 1 to 3. These equations are derived in a manner similar to Eq. 6.

First effect:

$$WS1 * \left[\frac{\lambda_{s1}}{\lambda_1} \right] - C_1 = 0 \quad \text{Where } WS1 = fs * WS \quad (8)$$

Second effect:

$$WS2 \left[\frac{\lambda_{s2}}{\lambda_2} \right] + C_1 \left[\frac{b_1}{\lambda_2} \right] + C_2 \left[\frac{b_1}{\lambda_2} - 1 \right] + \frac{P_V b_1}{\lambda_2} + \frac{PC_{PP}(T_3 - T_2)}{\lambda_2} = 0 \quad (9)$$

where, $WS2 = (1 - fs)WS$

$$b_1 = [T_3 C_{PW}(T_3) - T_2 C_{PW}(T_2)]$$

Third effect:

$$C_1 \left[\frac{\lambda_2 + b_2}{\lambda_3} \right] + C_2 \left[\frac{\lambda_2 + b_2}{\lambda_3} \right] + C_3 \left[\frac{b_2}{\lambda_3} - 1 \right] + \frac{PC_{PP}(T_4 - T_3)}{\lambda_3} + P_V \left[\frac{b_2}{\lambda_3} \right] = 0 \quad (10)$$

where, $b_2 = [T_4 * C_{PW}(T_4) - T_3 * C_{PW}(T_3)]$

Likewise, for the kth effect following equation is developed:

$$\sum_{j=1}^n [f_{kj}(WS1) + f_{kj}(WS2)] \frac{\lambda_{k-1} + B' + B'' + C_{k-1} \left[\frac{\lambda_{k-1} + b_k}{\lambda_k} \right]}{\lambda_k} + C_k \left[\frac{b_k}{\lambda_k} - 1 \right] + \frac{PC_{PP}(T_{k,s} - T_{k,t})}{\lambda_k} + A' + A'' + F' = 0 \quad (11)$$

where, $k = 4, 5, \dots, 7$ and

$$b_k = T_{k,s} * C_{PW}(T_{k,s}) - T_{k,t} * C_{PW}(T_{k,t})$$

$$A' = P_V * \left[\frac{\lambda_{k-1} + b_k}{\lambda_k} \right] \quad \text{for values of } k \text{ equal to } 5, 6 \text{ and } 7,$$

$$A' = 0.1$$

$$A'' = \frac{\lambda_{k-1} \sum_{j=1}^p f_{kj}(P_V) + P_V * b_k}{\lambda_k} \quad \text{for the value of } k \text{ equal to } 4, A'' = 0.$$

$$B' = \sum_{i=1}^{k-2} \left[\frac{\lambda_{k-1} * f_k(C_i) + C_i * b_k}{\lambda_k} \right] \quad \text{for the value of } k \text{ equal to } 5, 6 \text{ \& } 7, B' = 0.$$

$$B'' = \sum_{i=1}^{k-2} \left\{ \frac{\lambda_{k-1} * \sum_{j=1}^m f_{kj}(C_i) + C_i * b_k}{\lambda_k} \right\} \quad \text{for the value of } k \text{ equal to } 4, B'' = 0.$$

$$F' = F_V * \left[\frac{\lambda_{k-1}}{\lambda_k} \right] \text{ for values of } k \text{ equal to } 4 \text{ to } 6, F' =$$

0.

In Eq. 11, n represents the total number of vapor streams, produced from flashing of condensates of live steam from first and second effects as functions of Ws1 and Ws2, which enter into vapor chest of kth effect. For the values of k equal to 4, 5, 6 and 7, the values of n are 1, 2, 4 and 7, respectively. The value of n can be obtained in a manner similar to the computation of the values of n1 done in the case of condensate, CS, as can be seen in Table 3.

Similarly, m in Eq. 11 shows the total number of vapor streams generated from flashing of condensates C₁, C₂, C₃, C₄ and C₅ that enter into kth effect. These flashed streams are functions of C₁, C₂, C₃, C₄ and C₅. Likewise, p, represents the number vapor streams produced from P_V (vapor stream generated from product flashing) due to flashing and enter into vapor chest of kth effect. Eq. 11 can give rise to four different equations for values of k equal to 4, 5, 6 and 7, respectively. Overall mass balance around the SEFFFE system is given as:

$$\sum_{i=1}^7 C_i + P_V + F_V = F - P \quad (12)$$

Thus, Model-M3 consists of eight numbers of governing equations.

4. Solution of the Model

The model-M3 consists of a set of linear algebraic equations. The input variables of this model are F, x_F, x_P, F_V, P_V, T₀₁, T₀₂, T_F, T_P, fs, T₁, T₂, T₃, T₄, T₅, T₆ and T₇ whereas, output variables are categorized as Ws, C₁, C₂, C₃, C₄, C₅, C₆ and C₇. It should be noted that the complicated mathematical models used for screening of OFFS for the SEFFFE system under similar situation uses about 23 non-linear algebraic equations which need to be solved simultaneously or iteratively. During solution of these models in general convergence and oscillation problems are encountered. As the present model uses a set of linear equations far less in number from its counterparts it does not poses any convergence or stability problems. Thus the present model offers added advantages. The set of linear algebraic equations are solved simultaneously using Gaussian elimination method with partial pivoting.

5. Results and Discussions

Model-M3 is developed to screen the OFFS which will provide best steam economy. The values of steam consumptions (SC) for different FFSs, given in Table 2, are computed using Model-M3 and are shown in Fig. 6. It can be observed from this figure that the value of SC

varies from maximum to minimum in the following order of flow sequences: S5 > S6 > S4 > S3 > S2 > S1.

The steam consumption for a flow sequence mainly depends on two factors: sensible heating required for the entering liquor to bring it to the temperature of the effect and latent heat used for evaporation. In the present system as live steam is fed to effect no. 1 and 2 and so above two factors are computed for these effects for all feasible flow sequences and are shown in Table 4 which . This table clearly shows why value of SC changes with flow sequences.

The steam economy (SE) is defined as total amount of water evaporated divided by the amount of live steam consumed in first two effects. As for the present system the feed and product concentrations and feed flow rate remain same for all flow sequences and so the total water to be evaporated is equal in all cases. Thus, the value of SE varies inversely with SC as can be seen in Fig. 6. Table 4 shows that flow sequence, S1, is the OFFS as it consumes minimum amount of live steam and provides highest steam economy.

5.1. Comparison of Predictions of Model-M3 with Other Models

To check the effectiveness and reliability of the present model its predictions have been compared with the predictions of other simulation models [8], [3] & [6]. For this purpose Model-M3 is re-configured to suit the operating conditions and constraint of the above models. In fact, the above investigators have worked on different liquors such as chemical solution and milk and hence, the physical property correlations of these models were used in Model-M3 before solving it for comparison. The comparison is shown in Table5.

Kern [8] considered a triple effect evaporator (TEE) system for the concentration of chemical solution and predicted the OFFS based on minimum live steam consumption. The model was based on mass and enthalpy balance equations and considered negligible BPR, constant physical properties of solution and different OHTC for three effects. The predictions of Kern [8] are similar to that of Model-M3. Both show that the live steam consumption was minimum for backward FFS followed by forward FFS.

Nishitani and Kunugita [3] have used a TEE system employed for concentrating milk. Their model was based on thermal analysis and operating constraints as viscosity of liquid and formation of scale. Their criteria for selection of a set of non-inferior (a set of flow sequences which includes OFFS as well as near OFFSs in order of increasing total annual cost (TAC)) flow sequences is based on minimum heat transfer area and live steam consumption. The predictions of models due to Nishitani and Kunugita [3] and the present investigation are identical.

Bhargava [6] considered the SEFFFE system, shown in Fig. 1, and developed a rigorous nonlinear mathematical model for the simulation of above system by taking in to account the variation in -physical property, -BPR, -OHTC and -heat losses from effects. The model was validated using the data from a nearby paper mill. Both the models, Model-M3 and that of Bhargava [6], show backward flow sequences as OFFS.

From the above discussion it can be concluded that as far as the selection of OFFS is concerned there is no difference in the predictions of present model and that of other models.

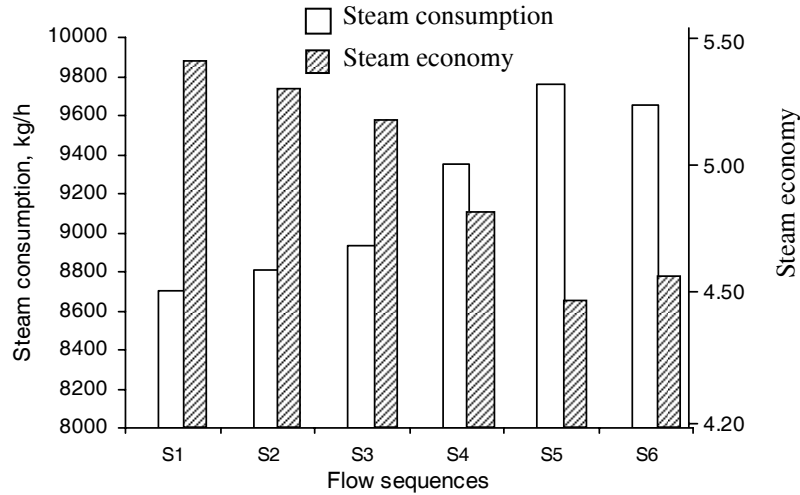

Fig. 6 The values of SC for different FFSs

Table 4 Computation of total heat supplied by steam for six flow sequences

Flow sequence(s) →	S1	S2	S3	S4	S5	S6
Effect No. 1						
Sensible heating inside the effect, kJ/h	0	0	0	0	0	5778327
Heat required for evaporation, kJ/h	9327959	9437151	9577384	10018473	10458122	4558120
Effect No. 2						
Sensible heating inside the effect, kJ/h	1052199	1058284	1066095	1090662	4229455	0
Heat required for evaporation, kJ/h	8181994	8284141	8415148	8827201	6125853	10229027
Total heat supplied by live steam, kJ/h	18562152	18779576	19058627	19936335	20813430	20565474

Table 5 Comparison of Model-M3 with other models

Description of model			Results		Remarks
No of effect	liquor	Problem	Model-M3	Model-X	
3	Chemical solution	F=22679.65 kg/h, $x_F=0.1$, $x_P=0.50$, $T_F=37.7$ °C, $T_L=51.7$ °C, $T_0=163$ °C, flow sequences: 123, 321	OFFS: 321	OFFS: 321	X: Kern [8]
3	Milk	F=15000 lb/h, $x_F=0.1$, $x_P=0.4$, $T_F=50$ °F, $T_L=107$ °F, $T_0=250.3$ °F, flow sequences: 123, 132, 213, 231, 321, 312	NFS: 321, 312, 213	NFS: 321, 312, 213	X: Nishitani and Kunugita [3] NFS: Noninferior flow sequence
3	Milk	F=15000 lb/h, $x_F=0.1$, $x_P=0.4$, $T_F=140$ °F, $T_L=107$ °F, $T_0=250.3$ °F, flow sequences: 123, 132, 213, 231, 321, 312	NFS: 213	NFS: 213	X: Nishitani and Kunugita [3] NFS: Noninferior flow sequence

7	Black liquor	System is shown in Fig. 1, operating parameters and flow sequences are given in Table 1 & 2, respectively.	OFFS : Backward	OFFS: Backward	X: Bhargava [6]
---	--------------	--	-----------------	----------------	-----------------

6. Conclusions

1. The Model-M3 can work as an effective screening tool for the selection of OFFS.
2. Out of the different FFSs investigated for SEFFFE system, the backward FFS was found to be optimal leading to highest value of steam economy.
3. The solution of the present model is easy and does not pose any instability or oscillation problems as generally observed in other simulation models based on sets of non-linear equations or based on iterations.

7. References

- [1]. Rao, N. J. and Kumar, Ram, "Energy Conservation Approaches in a Paper Mill with Special Reference to the Evaporator Plant", IPPTA International. Seminar on Energy Conservation in Pulp and Paper Industry, New Delhi, pp: 58-70 (1985).
- [2]. Harper, J. M. and Tsao T. F. "Evaporator strategy and optimization", In Computer Programs for Chemical Engineering Education, Vol. VI Design, (Ed. R. Jelinek), pp: 117-145, Aztec Publishing, Austin, Texas (1972).
- [3]. Nishitani, H. and Kunugita, E., "The optimal flow pattern of multiple effect evaporator systems", Computers and Chemical Engineering, Vol.3, pp: 261-268 (1979).
- [4]. Stewart, G. and Beveridge, G.S.G, "Steady state cascade simulation in multiple effect evaporation", Computers and Chemical Engineering, Vol.1, No.1, pp: 3-9 (1977).
- [5]. Ayangbile, W.O., Okeke, E.O and Beveridge, G.S.G, "Generalized steady state cascade simulation algorithm in multiple effect evaporation", Computers and Chemical Engineering, Vol.8, No.3/4, pp: 235-242 (1984).
- [6]. Bhargava, R., "Simulation of flat falling film evaporator network", Ph.D. Thesis, Department of Chemical Engineering, Indian Institute of Technology Roorkee, India, (2004).

- [7]. Westerberg, A.W. and Hillenbrand Jr. J. B. "The synthesis of multiple effect evaporator systems using minimum utility insights-II liquid flow pattern selection", Computers and Chemical Engg., Vol.12, No.7, pp: 625-636 (1988).
- [8]. Kern, D.Q., "Process Heat Transfer", McGraw Hill (1950).

8. Appendix A

The block diagram of primary condensate flash unit (PF1) is shown in Fig. A.1. In this diagram, condensate stream "CS" enters in to PF1 at temperature, T_0 , and is flashed at T_1 . As a result of it, vapor stream, CS_V , and liquid stream, CS_L , are generated. The mathematical expressions of these streams can be derived as:

Overall mass balance around PF1

$$CS = CS_V + CS_L \quad (A.1)$$

Energy balance around PF1

$$CS * h_s = CS_V * H_1 + CS_L * h_1 \quad (A.2)$$

Using Eqs. A.1 and Eq. A.2 following equation is obtained:

$$CS_V = \frac{CS * (h_s - h_1)}{(H_1 - h_1)} = \frac{Ws * (h_s - h_1)}{(H_1 - h_1)} \quad (A.3)$$

Eqs. A.1 and A.3 are used to predict the expression of CS_L as

$$\text{and } CS_L = (CS - CS_V) = Ws \left[1 - \frac{(h_s - h_1)}{(H_1 - h_1)} \right] \quad (A.4)$$

Following this pattern, the expressions of 15 streams as function of Ws can be derived.

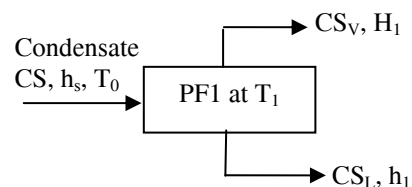

Fig. A.1 Block diagram of a primary condensate flash tank