

A Comparative Analysis of Packet Scheduling Schemes for Multimedia Services in LTE Networks

B. P. S. Sahoo*, Deepak Puthal[†], Satyabrata Swain[‡] and Sambit Mishra[‡]

*Department of Computer Science and Information Engineering, National Central University, Taiwan (R. O. C)

[†]Department of Computer Science and Engineering, National Institute of Technology Silchar, India

[‡]Department of Computer Science and Engineering, National Institute of Technology Rourkela, India

Email: {biswap.singh, deepak.puthal, satya.swain10, skmishra.nitrkl}@gmail.com

Abstract—The revolution in high-speed broadband network is the requirement of the current time, in other words here is an unceasing demand for high data rate and mobility. Both provider and customer see, the long time evolution (LTE) could be the promising technology for providing broadband, mobile Internet access. To provide better quality of service (QoS) to customers, the resources must be utilized at its fullest impeccable way. Resource scheduling is one of the important functions for remanufacturing or upgrading system performance. This paper studies the recently proposed packet scheduling schemes for LTE systems. The study has been concentrated in implication to real-time services such as online video streaming and Voice over Internet Protocol (VOIP). For performance study, the LTE-Sim simulator is used. The primary objective of this paper is to provide results that will help researchers to design more efficient scheduling schemes, aiming to get better overall system performance. For the simulation study, two scenarios, one for video traffic and other for VoIP have been created. Various performances metric such as packet loss, fairness, end-to-end (E2E) delay, cell throughput and spectral efficiency has been measured for both the scenarios varying numbers of users. In the light of the simulation result analysis, the frame level scheduler (FLS) algorithms outperform other, by balancing the QoS requirements for multimedia services.

Keywords—Long term evolution (LTE), cellular networks, packet scheduling schemes, quality-of-service (QoS), multimedia streaming.

I. INTRODUCTION

In the growing complexity of today's wireless communication systems; the cellular data networks are experiencing an increasing demand for its high data rate and wide mobility. In 2008, the Long Term Evolution (LTE) was introduced by the 3GPP¹ (3rd Generation Partnership Project) in order to increase the capacity and speed of wireless data networks. LTE and WiMAX are the two promising standards in the current cellular technologies. These two are also marketed as 4th Generation (4G) wireless services. LTE offers several important benefits for the subscribers as well as to the service provider. It significantly satisfies the users requirement by targeting the broadband mobile applications with enhanced mobility. With the introduction of Smartphone, the application like HDTV, online gaming, video meetings, etc are certainly become more valuable to the users. Hence, the users under-

stand and appreciate the benefits of LTE high data rates and services.

As one of the primary objective of the LTE network is to enhance the data-rate so as to cater the range of highly demanded services; the radio resources or data channels are divided and shared efficiently among different active users while considering a satisfied level of QoS to all active users. To shape the requirements, the LTE system uses orthogonal frequency division multiple access (OFDMA) technology in the down-link. The OFDMA technology divides the available bandwidth into multiple narrow-band sub-carriers and allocates a group of sub-carriers to a user based on its requirements, current system load and system configuration [1]. On that ground, collisions can happen more often among the active users while sharing the same data channel. Hence, it needs to take care by the resource allocation scheme. With 3G technologies, simple video services were attempted with attention focused on video telephony and multimedia messaging, and were somewhat successful. However, these technologies are still capacity limited and not able to economically support the huge mobile video demand that is emerging. This directly leads to the desire to use a broadband wireless network, such as LTE, for doing the same stuffs with greater speed and mobility. This can be mostly achievable by efficient resource allocation technique. Hence, the fast packet scheduling is one of the important data-rate improvement techniques among Link Adaptation, Multiple-Input and Multiple-Output (MIMO) Beam forming and Hybrid ARQ in 4G networks [12].

In this paper, we have studied packet scheduling algorithms that are proposed in the past year for LTE cellular networks in implication to multimedia services. A comparison of performance indexes such as average system throughput, end-to-delay (E2E), packet-loss-ratio (PLR) and fairness is reported for LTE systems over a realistic simulated scenario in multi-cell environment. The main goal this study is to provide results that will help in the design process of LTE cellular networks, aiming to get better overall performance.

The rest of the paper is organized as follows. An overview LTE of packet scheduler design and challenges are presented in Section II. Section III describes the recently proposed packet scheduling algorithms for LTE system. Section IV describes simulation scenario and examines the reported results. Finally, Section V concludes the paper.

¹<http://www.3gpp.org>

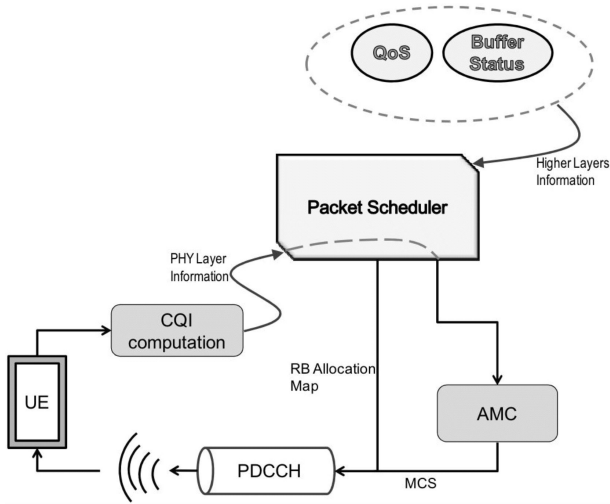

Fig. 1. Simplified model of a packet scheduler [1]

II. OVERVIEW ON SCHEDULING IN LTE SYSTEMS

The mobile broadband is a reality today and growing in very fast manner. 4G wireless systems such as 3GPP LTE features high data rate and low end-to-end latency which are the key requirements of multimedia applications, especially video and VOIP.

In order to support the rich demand of real-time multimedia services, it is necessary to ensure the QoS requirements are met and PLR is minimised by keeping it below the applications required threshold. Hence, multi-user scheduling is one of the main feature in LTE systems because it is in charge of distributing available resources among active users in order to satisfy their QoS needs. In a video streaming service environment, it is important to maintain the PLR threshold below 1% [2] such that the QoS requirements of video streaming service users are satisfied.

A simplified model of, how the main radio resource management (RRM) modules interact with the downlink packet scheduler is presented in Figure 1. Packet scheduling is one of the RRM functions and it is responsible for intelligent selections of users and transmissions of their packets such that the radio resources are efficiently utilized and the users QoS requirements are satisfied [11]. The whole process shown in the figure is repeated, in each transmission time interval (TTI) duration. The detailed procedure of, how the packet scheduler determines which users are to be scheduled is presented in [1].

The above outlined working flow slightly differs in the uplink direction as the eNodeB² does not need any additional information on the uplink channel quality.

III. SCHEDULING STRATEGIES FOR LTE SYSTEMS

The desire QoS for multimedia services is of growing importance for research and study LTE is the major step towards the 4th generation of cellular networks. Hence, the packet scheduling schemes to be used in LTE network should aim at

²The term 'eNodeB' is used to refer to base stations in 3GPP LTE.

maximizing the QoS while maintaining the fairness for these services. Different scheduling schemes have been proposed to support real-time (RT) and non real-time (NRT) services. In this section, we will illustrate the working principle of different packet scheduling algorithms that are suitable to use in LTE Systems.

The proportional fair (PF) [3] algorithm provides a good tradeoff between system throughput and fairness by selecting the user with highest instantaneous data rate relative to its average data rate. Its main objective is to provide maximum throughput while maintaining the fairness. To provide a maximum throughput, the algorithm attempts to serve each user at the peak of its channel condition, as a result, the scheduler will see a drop in channel condition temporarily for t_c seconds. A higher value of t_c allows the scheduler to wait longer for a users channel condition and hence improves overall average system throughput.

Suppose there are n users, let $R_i(t)$ be the estimated average rate for user i at slot t , and the current requested rate for user i is $d_i(t)$. The algorithm selects a user using following computation as:

$$P_i[n] = \frac{d_i(t)}{R_i(t)} \quad (1)$$

The user with the highest $P_i[n]$ out of all n users will receive the transmission at each decision time.

The maximum-largest weighted delay first (M-LWDF) [4] was originally designed to support multiple real-time data users in CDMA-HDR systems. The key feature of this algorithm is that the scheduling decision depends on both current channel conditions and the states of the queues. The M-LWDF serves in every TTI to the user with the highest priority. The priority of user i is computed as [9]:

$$P_i[n] = -\log(\delta_i) \cdot \frac{R_i[n]}{\lambda_i[n]} \cdot \frac{D_i[n]}{T_i} \quad (2)$$

where $P_i[n]$ denotes the priority of user i at the TTI number n , D_i the head of line (HOL) packet delay of user i , R_i the per-TTI maximum supportable data rate, T_i expresses the discard timer parameter for the user i , λ_i is an estimation of the average user throughput, and δ_i denotes a QoS parameter that allows to differentiate between users with different QoS priorities. The HOL packet delay $D_i[n]$ is defined as queuing delay d_j^i of the packet p_j^i that is located at the front of the queue Q_i at the TTI n .

The above discussed PF [3] scheduler is a suitable scheme for NRT traffic where as Exponential Proportional Fairness (EXP/PF) [5] was developed to support real-time multimedia applications. This algorithm has been designed to increase the priority of real time flows with respect to non-real time ones. The resources are allocated to users based on the following metric [11]:

$$P_i[n] = \begin{cases} \exp\left(\frac{a_i W_i(t) - a_i \overline{W}(t)}{1 + \sqrt{a_i W(t)}}\right) * \left(\frac{r_i(t)}{R_i(t)}\right), & i \in \text{RT} \\ \frac{w(t)}{M(t)} \frac{r_i(t)}{R_i(t)}, & i \in \text{NRT} \end{cases} \quad (3)$$

and:

$$\overline{aw(t)} = \frac{1}{N_{RT}} \sum_{i \in RT} a_i W_i(t) \quad (4)$$

$$w(t) = \begin{cases} w(t-1) - \varepsilon, & W_{max} > \tau_{max} \\ w(t-1) + \frac{\varepsilon}{k}, & W_{max} < \tau_{max} \end{cases} \quad (5)$$

Where $M(t)$ is the average number of packets at the eNodeB's buffer at time t, k and ε are constants, W_{max} is the HOL, the packet delay of RT services, and τ_{max} is the maximum delay of RT service users. The EXP/PF algorithm prioritizes RT traffic users over the NRT traffic users when their HOL delays are approaching the delayed deadline.

The frame level scheduler (FLS) [6] is a two-level scheduling scheme with one upper level and lower level. Two different algorithms are implemented in these two levels. A low complexity resource allocation algorithm based on discrete time linear control theory is implemented in the upper level. It computes the amount of data that each real-time source should transmit within a single frame, to satisfy its delay constraint. The PF [3] algorithm is implemented in the lower level to assign radio resources to the user, to ensure a good level of fairness among multimedia flows. The following equation calculates the amount of data to be transmitted.

$$u_i(k) = h_i(k) * q_i(k) \quad (6)$$

where $u_i(k)$ corresponds to the amount of data that is transmitted during the k th frame; '*' operator is the discrete time convolution. The above equation tells that the amount of data to be transmitted by the i th flow during the k th LTE frame is obtained by filtering the signal $q_i(k)$ (i.e., the queue level) through a time-invariant linear filter with pulse response $h_i(k)$.

The Optimized EXP rule [7] was proposed to provide QoS guarantees over a shared wireless link. The author claims that the proposed rule is throughput-optimal. This scheduling scheme explicitly uses the information on the state of the channel and queues and it ensures the queues stability without any prior knowledge of arrival and channel statistics of traffic.

This scheme defined two exponential rules for service a queue: the EXP (Queue length) rule (EXP-Q) and the EXP (Waiting time) rule (EXP-W). It chooses either EXP-Q or EXP-W rule to serve a queue with a fixed set of positive parameters such as: $\beta, \eta \in (0, 1)$ and $\gamma_i, a_i, i \in N$

$$\begin{aligned} i \in i(S(t)) &= \arg \max_i \gamma_i \mu_i(t) \exp\left(\frac{a_i Q_i(t)}{\beta + [\overline{Q}(t)]\eta}\right) \\ i \in i(S(t)) &= \arg \max_i \gamma_i \mu_i(t) \exp\left(\frac{a_i W_i(t)}{\beta + [\overline{W}(t)]\eta}\right) \end{aligned} \quad (7)$$

where $\mu_i(t)$ is the number of user served from the queue at time t , $\overline{Q}(t) = (\frac{1}{N}) \sum i a_i Q_i(t)$, and $\overline{W}(t) = (\frac{1}{N}) \sum i a_i W_i(t)$.

To provide a balance between mean-delay and throughput, the EXP rule maintains a lower delay by compromising the throughput, and eventually the mean delays and tails for almost all users.

The Optimized Logarithmic rule (LOG-Rule) [8] scheduler was designed to provide a balance in QoS metrics in terms of mean delay and robustness. It allocates service to a user in the same manner as EXP rule to maximize the current system throughput, assuming the traffic arrival and channel statistics are known. The author claims that the LOG rule is for a practical solution but, is not provably mean-delay optimal. For the LOG rule, the preference function is calculated as:

$$m_{LOG-Rule}^{i,k} = b_i \log(c + \alpha_i D_{HOL,i}) \Gamma_k^i \quad (8)$$

where b_i, c , and a_i are tuneable parameters; Γ_k^i represents the spectral efficiency for the i th user on the k th resource block.

A range of downlink packet scheduling algorithms are classified according to their design, principles and target achievements are presented in Table I.

To demonstrate the effectiveness of the above-studied schemes while considering several network conditions, scenarios with real-time multimedia flows are being analyzing on the impact of PLR, throughput, delay and fairness. Results will emphasize the effectiveness of these schemes describing how it is able to fully respect QoS requirements of multimedia flows with respect to other ones.

IV. SIMULATION FRAMEWORK AND RESULTS

In this section, we will discuss the simulation setup which is used in this paper to evaluate different scheduling schemes in multimedia traffic scenarios over LTE networks. The reported results have been studied and presented a comparison between video flows and VoIP flows. To compare the performance of the above-discussed scheduling algorithms, the LTE-Sim [10], an open source simulator for LTE networks was used.

A. Simulation Scenario

In real world scenarios, performance evaluation of a well-designed network model and the model itself carries significant importance. To perform the test, we defined a multicell scenario with a fixed eNodeB at the centre of the cell. The users are moving in a vehicular propagation environment in a bounded region of radius equal to 1 km with a speed of 60-120 kmph. Mobility of each mobile station or user equipment (UE) travelling cells is described with the random direction model. The number of connections to an eNodeB at a particular time varies from 20-200 UEs. Each UE receives one video flow and one VoIP flow at the same time. Table II gives the details simulation parameters used in the created simulation scenario for this paper.

B. Traffic Model

The video and VOIP streaming is treated as a real-time multimedia service. The real time video streaming traffic model can be described as continuous occurrence of video frames in a specific time interval. Video traces can be employed to simulate video traffic in a wide range of network simulations [18]. Video traces are used to generate video traffic workloads as well as to estimate the video related performance metrics, such as the frame starvation probability. In the studies

TABLE I
CLASSIFICATION OF SCHEDULING SCHEMES IN LTE

Scheduling Strategy	Scheduling Type	Service Target	Service Type
PF [3]	Opportunistic Based	Maximize throughput while maintaining fairness	Non Real Time
M-LWDF [4]	Opportunistic and Delay Based	Maximize throughput by ensuring delay	Real Time
EXP-PF [5]	Opportunistic Based	Maximize throughput by ensuring delay	Real Time
FLS [6]	Fairness Based	Ensure delay and a good level of fairness	Real Time
EXP-Rule [7]	Throughput Based	Maintains lower delay compromising throughput	Real Time
LOG-Rule [8]	Throughput Based	Maximize throughput and balanced QoS	Real Time
Round-Robin (RR) [15]	Fairness Based	Maximize fairness (but throughput degrades)	Both
Max-Rate [16]	Throughput Based	Maximized throughput (but results in low fairness)	Both

TABLE II
SIMULATION PARAMETERS

Parameters	Values
Simulation Duration	100 Sec
Frame Structure	FDD
Radius	1 KM
Bandwidth	10 MHz
Slot Duration	0.5 ms
Scheduling Time (TTI)	1 ms
Sub-career Spacing	15 kHz
Maximum Delay	0.1 ms
Video bit-rate	242 kbps
User Speed	60-120 KM
Traffic Model	H.264, Random Direction

reported here, in order to obtain a realistic simulation of an H.264 SVC video streaming, we have used an encoded video sequence “foreman.yuv³”, which is publicly available. The encoded spatial resolution CIF 352x288 with 300 frames per second has been used for the entire simulation.

The design and performance analysis of VoIP QoS techniques requires adequate traffic models. For VoIP streaming, this paper simulates a multiplexed packet-level VoIP traffic that lead to models for the packet arrival process of the inbound IP traffic from an IP gateway. The resulting traffic is a good approximation of the live traffic for the purpose of QoS traffic engineering.

C. Performance Metrics

The real-time multimedia performance under the above-discussed schemes is evaluated with below-listed metrics. All the metrics are related to QoS requirements except the cell throughput, which is a network related performance metric. Detailed descriptions of each metrics are provided as follows:

1) *Packet Loss Ratio*: Packet loss refers to the failure of one or more transmitted packets to reach their destination across a network. For real-time video service application, the packet loss should be maintained at a threshold less than 1% [2]. From Fig. 2(a), it can be concluded that all the schemes failed to meet the QoS requirements of video streaming service. In other hand, a VoIP user is satisfied if more than 98% of its voice packets are delivered successfully [13]. From Fig. 3(a), it can be observed that less than 60 and 80 UEs can be supported by PF and M-LWDF, EXP/PF, EXP-Rule, LOG-Rule schemes respectively. In other hand, the FLS scheme

outperforms all other schemes, meeting the target packet loss of around 2% by supporting 120 UEs. It is worth noting that VoIP flows experience significantly smaller packet loss than video services.

2) *Fairness*: Fairness is a major requirement that should be taken into account to guarantee a minimum performance to the cell-edge users. Figs. 2(b) and 3(b) show the fairness achieved for video and VoIP flows, respectively. It is possible to observe that the fairness decreases with increasing number of UEs, due to the higher network load. As the PF algorithm provides a good tradeoff between system throughput and fairness; when compare to all other schemes, the PF scheme still performs a poor. It is possibly due to its NRT oriented design. The FLS and EXP-Rule scheme performs significantly well when compared to all other schemes in lower number of UEs and gradually produce equal results in higher number UEs but FLS remains in the higher performing scheme for both scenario because the PF algorithm in lower level ensures a a good level of fairness among multimedia flows. Hence, it can be concluded that FLS is the best candidate for both flows in considering the fairness, the major performance metric.

3) *End-to-End Delay*: The End-to-End delay is the time required for a packet to be traversed from source to destination in the network and is measured in seconds. For quality voice and video service application such as Skype and Google+ Hangout, the packet E2E delay should not exceed 150 ms to evaluate that the quality of the created VoIP calls is accepted [13]. The result obtained from the video and VOIP quality assessment for delay variations are plotted in Fig. 2(c) and 3(c) respectively. As the PF [3] scheme was originally designed for NRT applications, the reflected result is beyond the target E2E delay of 150 ms. Hence, the PF scheme is not suitable for real-time multimedia applications. An interesting observation is seen among all schemes that E2E is almost uniform within the cell in both scenarios. Since there is very tiny difference in delay, which algorithm can best support VOIP services in the downlink LTE system is inconclusive.

4) *Cell Throughput*: The cell throughput performance for video and VOIP flows with increasing number of users is shown in Figs. 2(d) and 3(d) respectively. With increasing number of users, PF remains the worst performing scheme despite the tradeoff between fairness and throughput. As the FLS computes the amount of data that each real-time source should transmit within a single frame, which, in other words, take care to assign radio resources to users. The FLS scheme

³The video sequences are available at <http://trace.eas.asu.edu/yuv/>

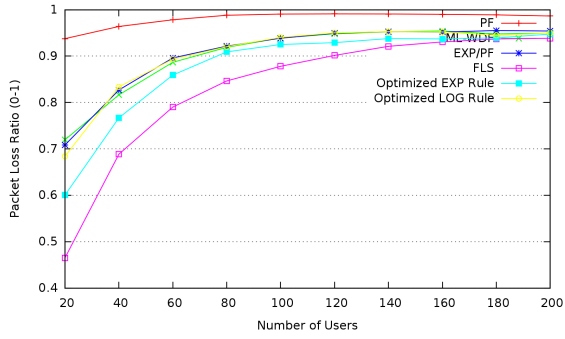

(a) Packet Loss Ratio Vs. Number of Users

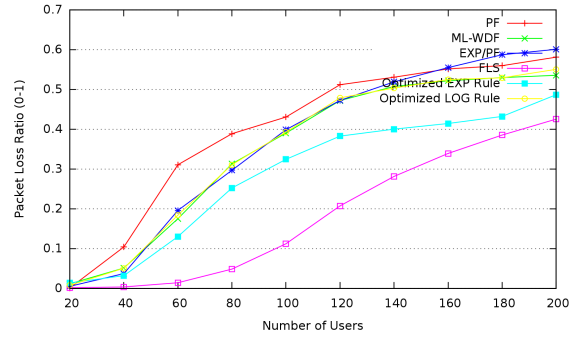

(a) Packet Loss Ratio Vs. Number of Users

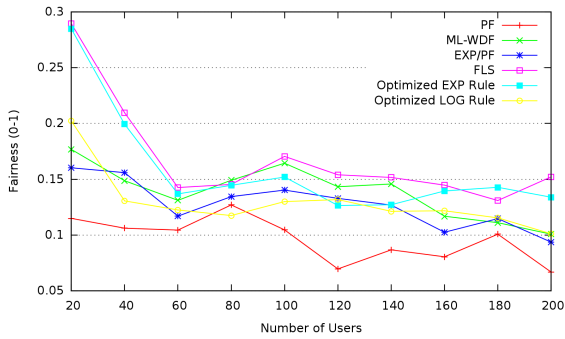

(b) Fairness Vs. Number of Users

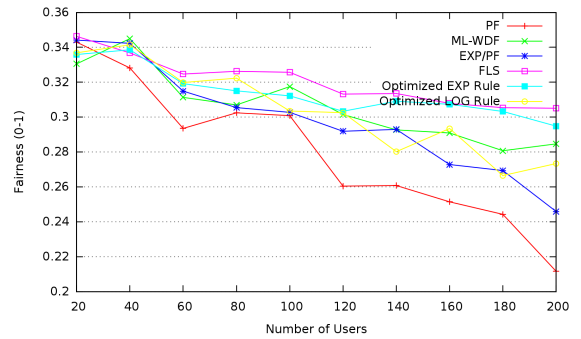

(b) Fairness Vs. Number of Users

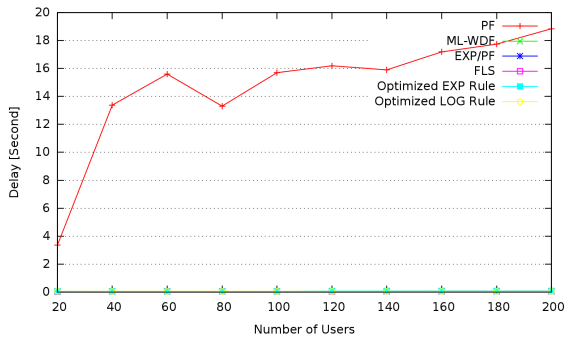

(c) Delay Vs. Number of Users

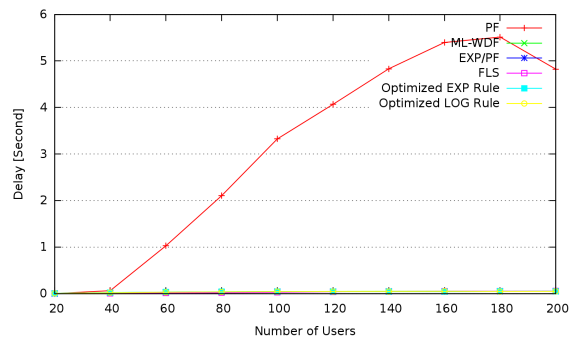

(c) Delay Vs. Number of Users

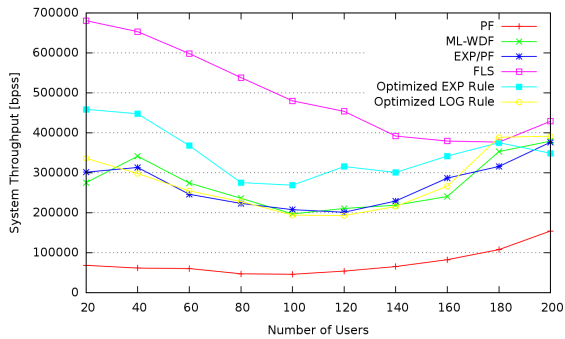

(d) Cell Throughput Vs. Number of Users

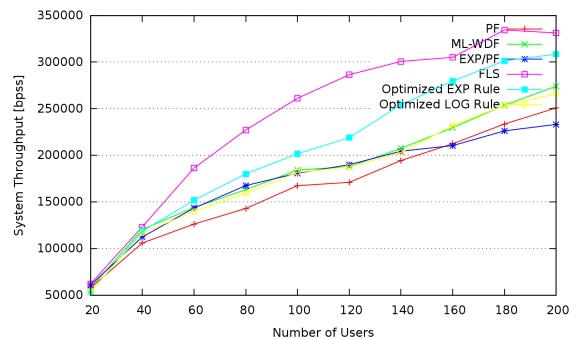

(d) Cell Throughput Vs. Number of Users

Fig. 2. Video Streaming Performance - Varying Number of Users

Fig. 3. VOIP Streaming Performance - Varying Number of Users

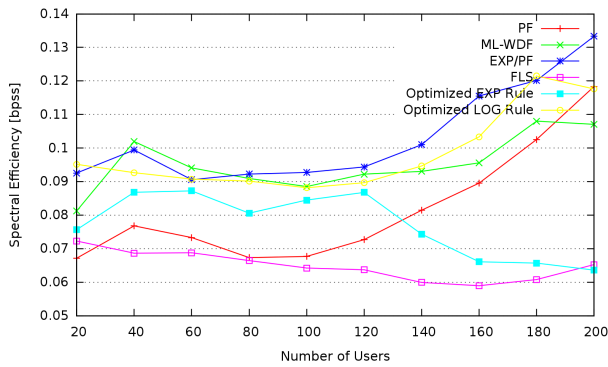

Fig. 4. Spectral Efficiency Vs. Number of Users

clearly has a very good cell throughput when compared to other schemes for video flows. But the worrying factor for VOIP flows which reflects in an unprecedented manner. In general throughput decreases with increasing number of UEs but here this is not the case. Hence, it is inconclusive for VOIP flows.

5) *Spectral Efficiency*: Successful usage of radio resources is one of the principle objectives to be accomplished. The spectral efficiency (SE) is regarded as the performance measures for the whole cell. Fig. 4 examines the performance in terms of SE for both scenario. The FLS approach achieves the lowest SE with varying number of users from 20 to 200 while the EXP/PF approach outperform all other schemes. When compared with EXP/PF scheme, the LOG-Rule scheme performs slightly better than the EXP/PF scheme on 20 number of UEs but performs slightly lower 20 users onwards while maintaining a good level of performance. The M-LWDF scheme can also be regarded as the competing approach when compared to EXP/PF and LOG-Rule scheme.

V. CONCLUSION

This paper evaluates the performance of few promising downlink packet scheduling algorithms for single carrier wireless systems, highlighting the work flow of a packet scheduler. The study was analysed with performance matrices such as packet loss, fairness, packet delay, system throughput and finally spectral efficiency over multimedia streaming traffic in a vehicular environment. The study explains the benefits and limitations of the packet scheduling schemes and its impact on multimedia traffic. During our studies, as obvious, we found that video streaming services required more resources, resulting poor performance compared to VOIP traffic analysis. The simulation results show that, FLS scheduling scheme outperforms other scheduler with lesser packet loss, providing better streaming quality and guaranteeing fairness at a satisfactory level too. As PF scheme was not designed for multimedia service, it has the worst performance in terms of delay. The FLS provides a higher throughput among all other scheduler for video streaming application while all scheduler behaves abnormally for VOIP streaming. Therefore, this study

stops by the conclusion that, so far, FLS is the best scheduler supporting video and VOIP streaming over LTE systems.

REFERENCES

- [1] Capozzi, Francesco, Giuseppe Piro, Luigi Alfredo Grieco, Gennaro Boggia, and Pietro Camarda. "Downlink packet scheduling in lte cellular networks: Key design issues and a survey." *Communications Surveys & Tutorials*, IEEE 15, no. 2 (2013): 678-700.
- [2] Janevski, Toni. *Traffic analysis and design of wireless IP networks*. Artech House, 2003.
- [3] Jalali, A., R. Padovani, and R. Pankaj. "Data throughput of CDMA-HDR a high efficiency-high data rate personal communication wireless system." In *Vehicular Technology Conference Proceedings*, 2000. VTC 2000-Spring Tokyo. 2000 IEEE 51st, vol. 3, pp. 1854-1858. IEEE, 2000.
- [4] Andrews, Matthew, Lijun Qian, and Alexander Stolyar. "Optimal utility based multi-user throughput allocation subject to throughput constraints." In *INFOCOM 2005. 24th Annual Joint Conference of the IEEE Computer and Communications Societies. Proceedings IEEE*, vol. 4, pp. 2415-2424. IEEE, 2005.
- [5] Rhee, Jong-Hun, Jack M. Holtzman, and Dong-Ku Kim. "Scheduling of real/non-real time services: adaptive EXP/PF algorithm." In *Vehicular Technology Conference*, 2003. VTC 2003-Spring. The 57th IEEE Semi-annual, vol. 1, pp. 462-466. IEEE, 2003.
- [6] Piro, Giuseppe, Luigi Alfredo Grieco, Gennaro Boggia, Rossella Fortuna, and Pietro Camarda. "Two-level downlink scheduling for real-time multimedia services in LTE networks." *Multimedia*, IEEE Transactions on 13, no. 5 (2011): 1052-1065.
- [7] Shakkottai, Sanjay, and Alexander L. Stolyar. "Scheduling for multiple flows sharing a time-varying channel: The exponential rule." *Translations of the American Mathematical Society-Series 2* 207 (2002): 185-202.
- [8] Sadiq, Bilal, Seung Jun Baek, and Gustavo De Veciana. "Delay-optimal opportunistic scheduling and approximations: The log rule." *IEEE/ACM Transactions on Networking (TON)* 19, no. 2 (2011): 405-418.
- [9] Andrews, Matthew, Krishnan Kumaran, Kavita Ramanan, Alexander Stolyar, Phil Whiting, and Rajiv Vijayakumar. "Providing quality of service over a shared wireless link." *IEEE Communications magazine* 39, no. 2 (2001): 150-154.
- [10] Piro, Giuseppe, Luigi Alfredo Grieco, Gennaro Boggia, Francesco Capozzi, and Pietro Camarda. "Simulating LTE cellular systems: An open-source framework." *Vehicular Technology*, IEEE Transactions on 60, no. 2 (2011): 498-513.
- [11] Ramli, Huda Adibah Mohd, Riyaj Basukala, Kumbesan Sandrasegaran, and Rachod Patachaianand. "Performance of well known packet scheduling algorithms in the downlink 3GPP LTE system." In *Communications (MICC), 2009 IEEE 9th Malaysia International Conference on*, pp. 815-820. IEEE, 2009.
- [12] B. Sahoo, "Performance Comparison of Packet Scheduling Algorithms for Video Traffic in LTE Cellular Network", *International Journal of Mobile Network Communications & Telematics (IJMNCT)* Vol. 3, No.3, PP 09-18, June 2013
- [13] Shen, Ng Liang, Noraniah Abdul Aziz, and Tutut Herawan. "End-to-End delay performance for VoIP on LTE system in access network." In *Information and Communication Technology*, pp. 162-172. Springer Berlin Heidelberg, 2013.
- [14] Sahoo, B. P. S., and Satyajit Rath. "Integrating GPS, GSM and Cellular Phone for Location Tracking and Monitoring." In *International Conference on Geospatial Technology and Applications*, Geomatrix 2012. IIT Bombay, 2012.
- [15] Dahlman, Erik, Stefan Parkvall, Johan Skold, and Per Beming. *3G evolution: HSPA and LTE for mobile broadband*. Academic press, 2010.
- [16] Tsybakov, B. "File transmission over wireless fast fading downlink." *Information Theory*, IEEE Transactions on 48, no. 8 (2002): 2323-2337.
- [17] Seeling, Patrick, Martin Reisslein, and Beshan Kulapala. "Network performance evaluation using frame size and quality traces of single-layer and two-layer video: A tutorial." *Communications Surveys & Tutorials*, IEEE 6, no. 3 (2004): 58-78.
- [18] Seeling, Patrick, and Martin Reisslein. "Video transport evaluation with H. 264 video traces." *Communications Surveys & Tutorials*, IEEE 14, no. 4 (2012): 1142-1165.