

# PERFORMANCE ENHANCEMENT OF POWER LINE COMMUNICATION

ANUJ GOYAL

ELECTRONIC AND COMMUNICATION  
NATIONAL INSTITUTE OF TECHNOLOGY  
ROURKELA, ODISHA  
[anuj17goyal@gmail.com](mailto:anuj17goyal@gmail.com)

SARAT KUMAR PATRA

ELECTRONICS AND COMMUNICATION  
NATIONAL INSTITUTE OF  
TECHNOLOGY ROURKELA, ODISHA  
[patra.sarat@gmail.com](mailto:patra.sarat@gmail.com)

**Abstract**— The objective of this paper is to address the problem and reaching out to the solution of the best possible technique for modulating a signal so as to transfer it successfully over a channel while ensuring the speed and robustness of the channel. The main purpose of doing so is to upgrade the performance of the PLC mainly for smart grid applications. To achieve this there is a requirement to go through the glimpse of history and approach towards exploration of most recent technological advances in this field. To do so the very first step is to do the circuit analysis and modeling of the indoor power line communication and the second is the determination of control and traffic problems. Then we will approach toward the channel analysis using different modulation schemes, at the very same time the speed and robustness of the channel should be the very first requirement, so OFDM could be one of the best candidate, however in case of interfacing between wired and wireless communication (as required in case of long haul communication and power failure) CDMA could prove to be a more useful one.

*Keywords*-Power line communication, Smart grid, Channel model, Transfer function, modulation schemes, OFDM, CDMA.

## I Introduction

Few decades before the power line communication was meant for the purpose of deliverance of energy to ensure that the devices or the appliances gets the desired power required for their operation which is usually a one way communication. But when it comes to last few years another feather has been included in the usage of power line communication i.e. energy management and improvement in efficiency which makes it to be a two way communication and this is mainly possible when we approach for intelligent monitoring and reliable deliverance of power which could only be achieved if we knows the control and traffic problems which is dependent on to a proper model as well as the best suited technique of data transmission over power line cables.

### *Ease of Use*

In this paper firstly we have presented the basic functionality of power line communication in section –II then we had gone

through a small retrospective view of power line communication to determine the work already done and the current status in section-III, which also involves the basic propagating model, In the next section we have determined the physical signal propagation effects and control and traffic problems thereafter some of the simulation results had been depicted which is followed by the concluding remarks.

## II Functionality of power line communication in the smart grid

Smart grid could be used at all voltage levels HV, MV and even at the low voltage sites inside the buildings. Although over the years it mainly finds out the applications with a higher growth rate mainly at the low voltage sites for various applications like [see-1]

- (1.) Automatic Meter Reading - It not only allows the billing services to be achieved in an optimized manner but also facilitates the customer to get through the real time information of the electricity pricing.
- (2.) Vehicle to Grid Communication - This is widely deployed service in developed countries. Although in developing countries it may take some time to become feasible. It allows the charging up of the batteries of the vehicle whenever they get connected to the premises wiring or the outlet cables.
- (3.) Demand Side Management - It could be said as an enhancement over the existing applications as this allows the management of power in accordance with the generation rate.
- (4.) Home Automation - The Power Line Communication could be used for the purpose of achieving automation at the customer premises and this will ensure better usage and conservation of available power because considering the availability of the resources which is dwindling on a continuous basis and the growing demand for the energy which is rising almost with the same rate.

Moreover the power line communication also finds its utility for medium voltage networks and high voltage networks up to some extent .PLC over high voltage lines can be used for the purpose of fault detection and in case of medium voltage

networks it is useful for checking out the power flow conditions.

### III Retrospective View of PLC

The power Line communication has started gaining the importance at a very fast pace during the last few year. It is always a difficult task to categorize the communication so one of the ways is to approach towards the categorization on the basis of frequency division. Hence power line communication could be categorized as Ultra Narrowband, Narrowband and Broadband.

#### Ultra Narrowband and Narrowband PLC

The first deployment regarding the UNB-PLC technologies involve the Turtle system and Twacs. Both system makes use of outbound communication for voltage (substation to meter) and inbound communication for current (meter to substation).For Low Voltage (LV) distribution PL i.e. Narrowband PL is in the frequency range of 3 kHz to 148.5 kHz

Four frequency bands are defined (see [1])

1. (3-95 kHz): reserved exclusively to power utilities.
2. (95-125kHz): any application
3. (125-140 kHz): in home networking systems with mandated carrier sense multiple accesses with collision avoidance protocol.
4. (140-148.5 kHz): alarm and security.

#### Broadband PLC

In this field the first research had been started for internet access applications and successively for HAN and A/V applications. In UK the Nor web communication have started work to provide the broadband internet access to the customers on a trial basis and were successfully achieved the deliverance of services on the line at the rate of 1Mbps. Later a multilayer project funded by the European community (OPERA) led most of the recent research efforts in the field of BB-PLC for internet access.

#### Common Wiring Practices Used in Residential and Business Buildings

In general the power cables used for power for single phase indoor wiring consist of three or four conductors in addition to the ubiquitous earth ground. These usually include hot (black), return (white), safety ground (green or bare) and the occasional runner(red) wires, all confined by an outer jacket that maintains close conductor spacing between two directions of propagation. The spatial modes are often referred to as differential mode or

balanced mode and common mode is referred to as the longitudinal mode.

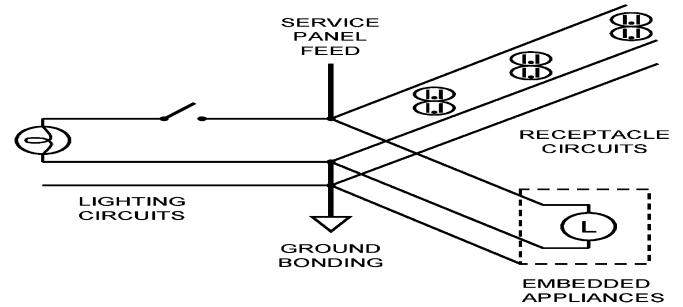

Fig-1 Layout of typical residential and commercial premises [3]

#### Reflection Coefficient in a Transmission Line

The voltage and current in a three wire power line cables consists of  $V_{blk}(I_{blk})$ ,  $V_{wht}(I_{wht})$  and  $V_{gnd}(I_{gnd})$  respectively. In a three conductor cable there is a presence of three spatial modes which involves differential, pair and common modes, each for two direction of propagation.

The propagating voltages are  $V_1^+ = (V_{dif}^+, V_{pr}^+, V_{cm}^+)$  and  $V_1^- = (V_{dif}^-, V_{pr}^-, V_{cm}^-)$ , correspondingly the current relationship is given by  $I_1^+ = (I_{dif}^+, I_{pr}^+, I_{cm}^+)$  and  $I_1^- = (I_{dif}^-, I_{pr}^-, I_{cm}^-)$ . [see-3]

Where these two terms are related via a reflection coefficient as given by  $V_1^- = \rho_v V_1^+$  and the reflection coefficient is further defined in terms of an arbitrary linear network described as  $Z_{term}$ , is given by

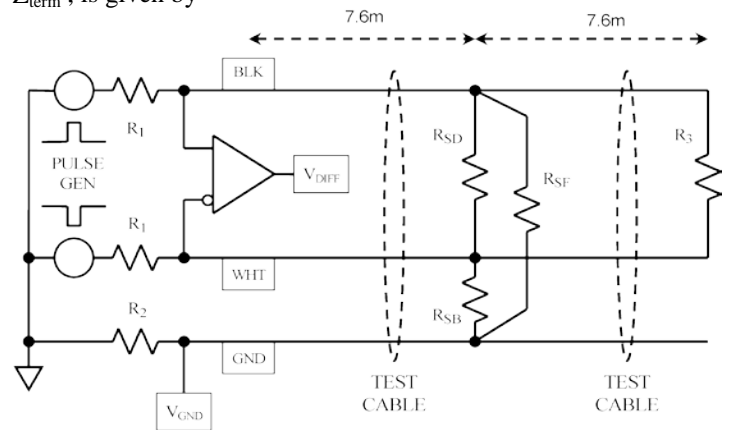

Fig-2 Physical model defines the basic connection of three different types of resistors  $R_{sd}$  (differential resistance),  $R_{sb}$  (bonding resistance),  $R_{sf}$  (fault resistance) [2].

$$\rho_v = (A^T Z_0^{-1} + Z_{term}^{-1} B^T) (A^T Z_0^{-1} - Z_{term}^{-1} B^T) \quad (1)$$

Where A and B are modal matrices as define in [3, eqs (3) and (4)],  $Y_{term}$  is defined as

$$Y_{term} = (Z_{term})^{-1} = A^T Z_0^{-1} A + Y_{sh} \quad (2)$$

On substituting this in the above equation we get

$$\rho_v = -(2A^T Z_0^{-1} + Y_{sh} B^T)^{-1} Y_{sh} B^T \quad (3)$$

Moreover there is a description of mode coupling resulted in between differential and bonding resistance and between differential and fault resistance. Considering all these there is a presence of reflection coefficient which is related to bonding and fault condition and is described below and these are mainly resulted due to shunt branches as depicted in the basic topological diagram

The differential mode reflection coefficients for each case are

$$\frac{-1}{\rho(dif_{rb})} = 1 + \frac{8 * R_{zb}}{(1 - \epsilon)^2 * Z_{dif}} + 4 * \frac{Z_{pr}}{(1 - \epsilon)^2 * Z_{dif}}$$

and

$$\frac{-1}{\rho(dif_{rf})} = 1 + \frac{8 * R_{zf}}{(1 + \epsilon)^2 * Z_{dif}} + 4 * \frac{Z_{pr}}{(1 + \epsilon)^2 * Z_{dif}}$$

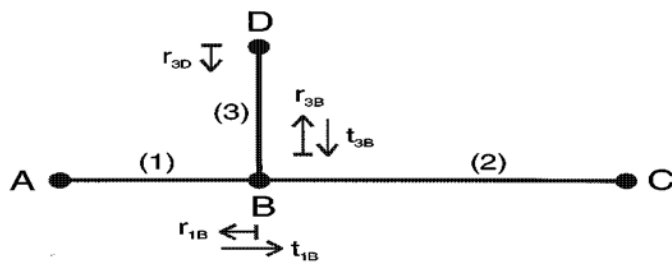

Fig-3 Multipath signal propagation cable with one tap.[4]

As depicted in the above figure that along a single transmission line, to provide a connection to a number of terminals a shunt branch is required to be taken off and this is to be terminated to the appliance or to the device. Now as the signal approaches towards the receiver from the transmitter there could be a presence of reflective signals not only from the end of the transmission line but also from the shunt

branches and this is mainly resulted due to mismatching of the load or the shunt branch. Moreover the wiring irregularities and improper insulation could lead to radiation losses.

Thus this reflection coefficient varies as function of resistance and hence the relationship is as shown in fig.4 for two conditions:-Bonding ( $R_{sf}=R_{sd}=\infty$ ) and Fault ( $R_{sd}=R_{sb}=\infty$ ) (see [2, 3]).

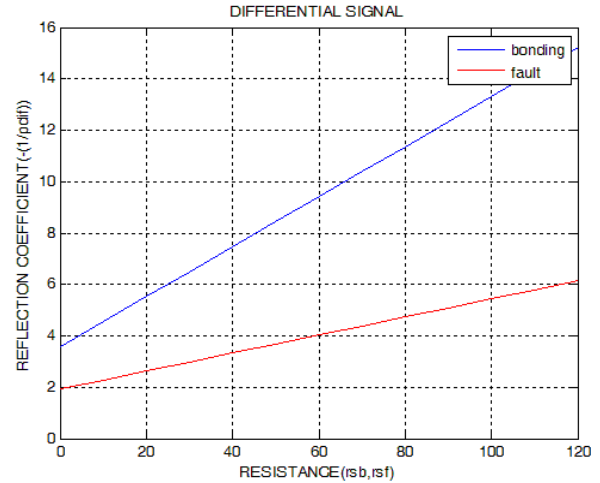

Fig-4 Variation of reflection coefficient for bonding and fault condition with respect to resistance

#### IV Physical Signal Propagation Effects

This section examines the effects on the communication signals over power line networks. The signal propagation takes place not only along a direct line of sight path but additional echoes must also be considered. This results in a multipath scenario with frequency selective fading. All the reflection and transmission factors are less than or equal to unity and the product of it is defined as weighting factor  $g_i$ . Furthermore the longer the transmission paths the higher the attenuation.

The delay of a path is defined as

$$\tau_i = d_i / v_p$$

The losses along the cable increases with length and frequency. Therefore the overall frequency response is defined as

$$H(f) = \sum_{i=1}^N g_i * e^{(-j2\pi f(\frac{d_i}{v_p}))} * e^{-(\alpha_0 + \alpha_1 * f^k)}$$

Where, N is the number of paths and  $g_i$ ,  $\alpha(f)$ ,  $l_i$ , are the gain/weighting factor, attenuation factor and delay of each path respectively.[4]

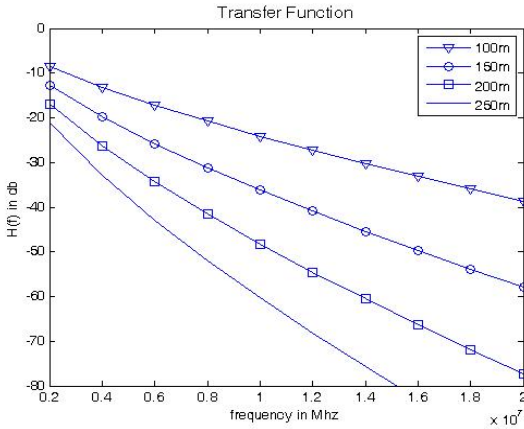

Fig-5 Transfer Function of PLC in the frequency range of 500 KHz -20 MHz.

### Control and Traffic Problems

Basically some of the control and traffic problems arise in the case whenever we are willing to provide an extension of services to remote locations, as in case of rural areas or some other deprived areas where the robustness of the channel is of primary concern as compared to the speed. However in case of long haul communication in urban locations and for inter-country or inter-continental communication where the speed and endurance both are of main concern, considering these challenges we have approached for the channel analysis using OFDM which could prove its utility according to conditional requirements .

### V Performance Analysis of the System and Simulated Results

A number of modulation schemes have been used for the purpose of channel performance determination like ASK, FSK and many more. But keeping the fact of requiring robustness and higher data rate OFDM could be the best suited case. Thus using OFDM (BPSK, QPSK AND QAM) the simulated results are as shown below.

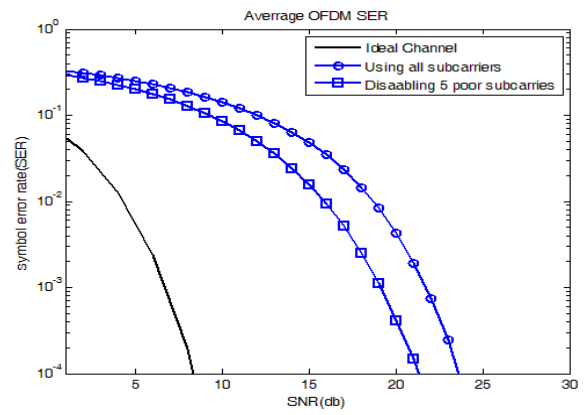

(a)

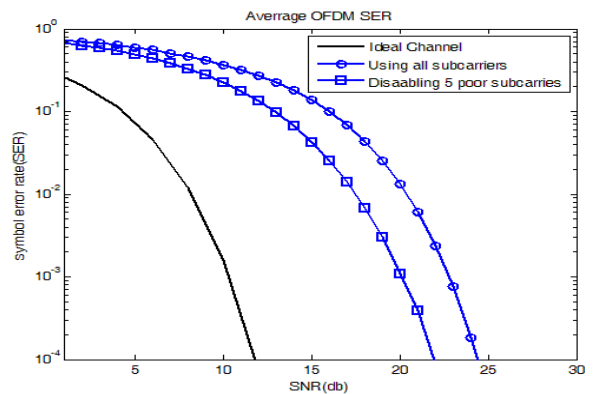

(b)

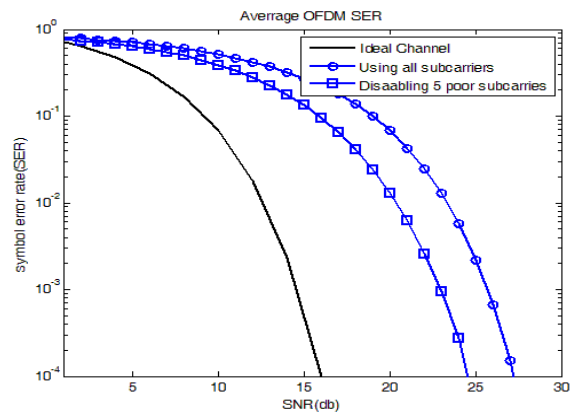

(c)

Fig-6 Analysis of power line communication channel and determination of symbol error rate using (a) OFDM BPSK (b) OFDM QPSK, (c) OFDM 16-QAM

## VI Conclusion and Future Possibilities

In this paper, a model of the complex frequency response of the power line communication links for the frequency range from 500 KHz to 20 MHz has been analyzed using OFDM modulation schemes and on the basis of analyses and the obtained results we find that there is trade-off between the complexity and the desired performance.

Furthermore there is one of the biggest limitation of PLC is power failure which is becoming more and more common now a days. The solution lies in the fact that we can provide an interface between wired and wireless communication in case of adverse conditions like power failure and this interfacing could also be a fruitful solution to reach to remote locations and for intercontinental communication and to achieve it we can make use of VSAT (very small aperture terminals) i.e. making use of satellite communication and hence spread spectrum techniques.

## References

- [1] Stefano Galli, Senior Member IEEE, Anna Scaglione, Fellow IEEE, and Zhifang Wang, Member IEEE, For the Grid and Through the Grid: The Role of Power Line Communications in the Smart Grid, Proceedings of the IEEE [Vol. 99, No. 6, June 2011
- [2] S. Galli and T. Banwell, B , A deterministic frequency-domain model for the indoor power line transfer function ,IEEE J. Sel. Areas Communication., vol. 24, no. 7, pp.1304–1316,Jul.2006.
- [3] T. Banwell and S. Galli, “A novel approach to accurate modelling of the indoor power line channel—Part I: Circuit analysis and companion model,” IEEE Trans. Power Del., vol. 20, no. 2, pp. 655–663, Apr. 2005.
- [4] M. Zimmermann and K. Dostert, “A multipath model for the power line channel,” IEEE Trans. Communication., vol. 50, no. 4, pp. 553–559, Apr. 2002.
- [5] D.Nordell,”Communication systems for distribution automation,” in Proc. IEEE transm. Distrib. Conf. Expo., Bogota, Columbia, Apr. 13-15, 2008
- [6] G. Bumiller, L. Lampe, and H. Hrasnica, “Power line communication networks for large-scale control and automation systems,” IEEE Commun. Mag., vol. 48, no. 4, Apr. 2010.